



AVT 3.0

Accelerated Vibration
Training™ Machine

Owner's Manual



3G Cardio LLC
Phone: 1-888-888-7985
Online: www.3GCardio.com

IMPORTANT! PLEASE READ:

If you purchased your 3G Cardio product from an online retailer (3GCardio.com, Amazon, Costco etc..) and need help or have questions, comments or concerns, please call or email us (3G Cardio) directly. We are not operators, we are experienced fitness professionals and can help you with anything and everything!

If you purchased your 3G Cardio product from a “brick and mortar” retail store, feel free to contact the store directly with any questions or concerns. You are still more than welcome to contact us too!



3G Cardio Fitness Equipment
14647 So. 50th Street Suite 110
Phoenix, AZ 85044

1-888-888-7985
www.3GCardio.com
support@3gcardio.com

© Copyright 3G Cardio LLC
All Rights Reserved



Table of Contents

Accelerated Vibration Training™	1
Frequently Asked Questions	3
Safety Precautions	4
Warnings and Moving Machine	5
Features	6
Assembly Part List	7
Assembly	8 - 10
Console Operation AVT 3.0	11 - 12
Exercise Instructions	13 - 18
Warranty Information & Registration	19 - 20
Parts List and Exploded Drawings	22 - 24

Welcome to Accelerated Vibration Training™ (AVT)

People all over the world are enjoying dramatic and exciting benefits through Accelerated Vibration Training™ (AVT). Whether you're a professional athlete or the retired couple next door, Accelerated Vibration Training™ will build and tone your muscles, build your reflex pathways, improve your circulation and balance, and much more.

The 3G Cardio AVT 3.0 Accelerated Vibration Training™ Machine you have purchased is among the elite Accelerated Vibration Trainers available on the market today.

What is Accelerated Vibration Training?

Accelerated Vibration Training is an exciting and revolutionary approach to physical fitness which greatly accelerates the traditional process of muscle strengthening and development.

In order to build stronger and better-toned muscles and, coincidentally, to burn fat, muscles have to be used – fatigued and stressed - and muscle fibers have to be broken down. After a brief period of time, generally 24-48 hours, muscles regenerate with better tone and stronger fiber, burning fat in the process.

Traditional fitness training such as weight lifting accomplishes this by the use of increasing repetitions and increasing weight. In 2009, experts at 3G Cardio coined the term Progression of Muscle Fatigue to describe what happens to muscles during traditional fitness training. Basically, as muscles are stressed and fatigued during workout sessions, the stress and fatigue gradually and slowly begin to spread through the muscle layers, breaking them down.

As the number of repetitions and the weight are increased, stress and fatigue slowly and gradually continue to spread through the muscle layers and then into layers of neighboring muscles. In traditional fitness training, Progression of Muscle Fatigue is a slow and gradual process.

Accelerated Vibration Training is an exciting advancement in fitness training because it causes the Progression of Muscle Fatigue to happen almost instantaneously.

The motor in the 3G Cardio Accelerated Vibration Training™ Machine causes the platform you stand on to rapidly vibrate up and down. The vibrating machines create instability, which stimulates muscles to near peak capacity. This creates stress and fatigue in muscles by causing muscles to reflexively and involuntarily contract - up to an amazing 30-50 times per second.

This leads to a near instantaneous Progression of Muscle Fatigue, which means the muscles are being stimulated to near peak capacity, maximizing muscle strengthening and flexibility, without putting undue stress on ligaments and joints.

As you hold various exercise positions (such as Squat, Bent-Over Row, Lunge, Shoulder Press, Stretch Poses, and Massage Poses) the machine sends vibrations into the activated muscle groups. These vibrations stimulate “fast-twitch” muscle fibers and force reflexive alternating muscle contractions and relaxations to occur.

The basic physics for Force are defined by Sir Isaac Newton's equation: $F = m \times a$ (Force equals mass times acceleration).

The stimulus for the Force on the body is reversed with 3G Cardio Accelerated Vibration Training™ Machines. Instead of the mass being increased with weights and higher numbers of repetitions as in traditional strength training, the mass is powered up by the vibrating plate, and the acceleration is increased. The increase in acceleration can produce the same or even better results than increasing the weights, and with a greatly decreased risk of injury.

Why Will I Benefit From Accelerated Vibration Training™?

When we're young we run, jump, climb, crawl, and roll, day in and day out. As a result, muscles are stimulated to a high degree. Unfortunately, as we get older our daily activity decreases and we stop using many of the different muscle fibers.

In today's fast-paced world, few people have hours to spend working out in a gym to compensate for this decreased activity. And those who do get to the gym regularly often have gaps in their programs and are not reaching optimum levels for stimulating their fast-twitch muscles. Also, factors such as injuries, lack of flexibility, lack of a workout partner, lack of time, and waning determination can limit the benefits of membership in the local gym.

The 3G Cardio AVT 3.0 Accelerated Vibration Training™ Machine offers an enjoyable and stimulating experience in strength training right in your own home, with much lower risk to joints and ligaments, and in a fraction of the time and effort free weights require.

Many people use the 3G Cardio AVT 3.0 Accelerated Vibration Training™ Machine as their exclusive fitness activity because of the vast number of exercises they can do on it. Many others find it to be a great cross training tool to complement other fitness activities.

What Are Some of the Benefits of Accelerated Vibration Training™?

Accelerated Vibration Training™ provides an easier and more effective total body workout than traditional regimes, with less risk of injury. AVT will:

- Improve muscle strength and tone
- Improve balance
- Improve bone health and density
- Improve circulation and cardio health
- Improve the efficiency of respiratory system
- Aid in rehabilitation
- Stimulate the kinetic system
- Stimulate the nervous system
- Promote weight loss
- Stimulate secretion of anabolic hormones
- Awaken reflex pathways
- Aid in the cleansing of the lymphatic system
- Allow the body to experience stress more easily and with less risk of injury than with traditional weight lifting or cardio training

Does Accelerated Vibration Training™ Really Work?

The answer is a resounding "yes" based on years of study and research by 3G Cardio. The new 3G Cardio AVT 3.0 Accelerated Vibration Training™ Machine uses your body's own reflexes to help you reach your fitness and health potential.

Whether you're a younger athlete looking to cross train, or an older person who's had trouble working out because of pain and/or lack of flexibility, the 3G Cardio Accelerated Vibration Training™ Machine can greatly improve your fitness level and overall health.

For Seniors, or people dealing with severe health problems, Accelerated Vibration Training™ offers a new sense of empowerment by providing a safe way to exercise.

Frequently Asked Questions

Q: Should I talk to a doctor before starting a training program on the Accelerated Vibration Training™ (AVT) Machine?

A: Yes. It's always recommended to consult a physician before starting any new conditioning regimen. During your workout, if you experience dizziness, shortness of breath, pain, or discomfort, stop using the machine immediately and consult a physician. Please be aware that if you have any known medical conditions with your eyes you will need to consult with your eye doctor prior to using this machine. Some people with eye / retina issues may be predisposed to complications when exposed to certain types of vibrations and impact.

Please read this entire manual for the complete list of contraindications.

Q: Can I use the 3G Cardio AVT Machine every day?

A: It's actually recommended that you allow 24-48 hours between workout sessions, as your muscles need that time to break down and rebuild stronger. You will gain a feel for just how much recovery time you need. However, you can use the Accelerated Vibration Training™ Machine for massage and stretching on a regular basis.

Q: Can the 3G Cardio AVT Machine be used by Senior Citizens?

A: If your doctor has given you the okay, then we say, welcome aboard! Not only can Seniors use the Accelerated Vibration Training™ Machine, but Seniors are one of the groups who can benefit from it the most.

Many Seniors are using Accelerated Vibration Training™ to strengthen and coordinate muscles, and as a treatment and preventative tool to battle Osteoporosis.

One of the major reasons bones weaken is lack of exercise. Accelerated Vibration Training™ (along with taking important nutrients such as calcium) is a great way to potentially slow, stop or reverse the process of bone loss. When muscles are activated, strain is also applied to the bones, which makes the bones stronger as well.

Q: Can Accelerated Vibration Training™ help me lose weight?

A: It most certainly can. As people build muscle they burn more calories, which helps them to increase their metabolic rate and become leaner. Studies show Accelerated Vibration Training™ can also help combat cellulite through improved circulation and the massage effect on skin and tissues.

3G Cardio always encourages clients to call with questions. We love to talk fitness and we know our own products very well. Please do not hesitate to email us at Support@3GCardio.com or call 888-888-7985.

Safety Precautions

Thank you for purchasing the 3G Cardio AVT Vibration Machine. Even though we go to great efforts to ensure the quality of each product, occasional errors and/or omissions do occur.

Should you find this product to be defective or missing a part please contact us at Support@3GCardio.com or call 888-888-7985 and we will assist you to resolve the problem.

You can also contact the store at which you made your purchase.

Be sure to read the entire manual before assembly and operation. Also, please note the following safety precautions:

1. Before beginning any exercise program, consult your personal physician. If you experience any pain or tightness in your chest, irregular heartbeat, shortness of breath, faintness, dizziness, or any other unusual discomfort while exercising, stop and consult your physician before continuing.
2. Unless authorized by 3G Cardio, under no circumstance should you attempt any type of service.
3. Only authorized personal are permitted to service a 3G Cardio machine.
4. No person weighing over 350 lbs. should use this product.
5. Only one person at a time should use this equipment.
6. Always use this AVT Vibration Machine on a clear and level surface.
7. Do not use outdoors or near water.
8. Do not attempt to enter or exit the machine until it stops.
9. Keep children and pets away from this equipment at all times.
10. As with all exercise equipment, adequate warm up/cool down time is always recommended.
11. Inspect your machine prior to exercise to ensure that all nuts and bolts are fully tightened.
12. Turn off the power switch after use.

Contraindications Include:

- Pregnancy
- Acute thrombosis conditions
- Cardio-vascular disease
- Fresh wounds resulting from an operation or surgical intervention
- Recent hip and knee replacements. Consult Doctor/Surgeon for approval.
- Acute hernia, discopathy, spondylitis
- Epilepsy
- Existing eye / retina medical conditions
- Heavy migraine
- Wearing recently fitted i.u. coils, metal pins, bolts or plates

For additional contraindications and a more thorough review of your own situation, consult your doctor.

Warning about mishandling or unauthorized usage

1. You always need to be balanced when standing on the vibration machine.
2. Never hang on to the handle, or push handlebar with strength. Use them only to maintain balance. While this is a very durable machine, mishandling, aggressive or excessive force on the uprights, and other service issues resulting from improper use may result in damage to the machine. Unauthorized use may result in damage to the machine which will not be covered under the 3G Cardio Warranty.
3. Always wear the proper clothing and footwear and always familiarize yourself with the operations of any piece of exercise equipment.
4. Consult a doctor prior to starting any exercise program. If you feel faint or dizzy you should stop exercising immediately and refrain from using until you receive a doctor's approval.
5. This is not a toy. Please keep kids and animals away from unit and exercise common sense while using.

Moving the Machine after Installation

1. Due to the weight of this machine, please exercise caution while lifting or moving.
2. Never attempt to drag or slide machine as it may damage your floor or the unit.
3. Never drop the unit as this will result in damage.
4. Please ensure that the power cord is removed and not caught under the unit.

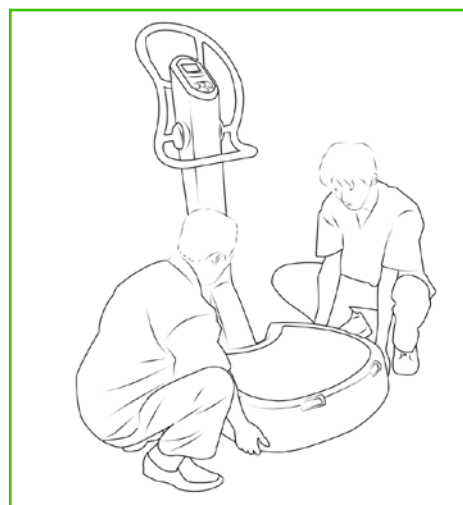

The following moving methods are prohibited as they can damage the column.

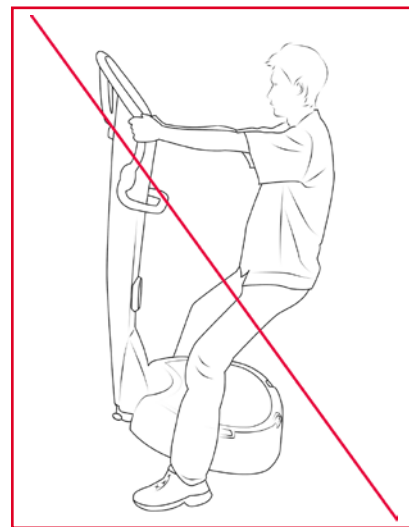
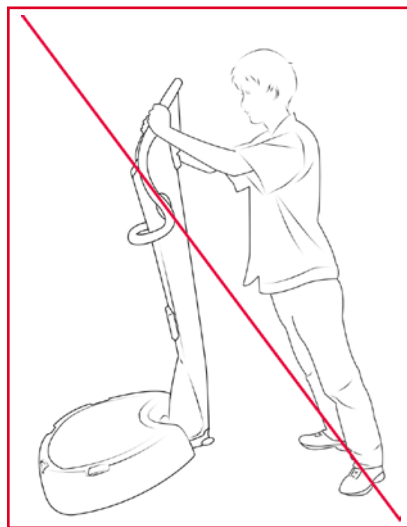
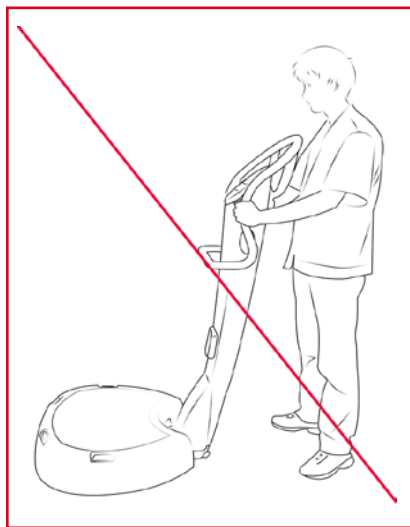

Features

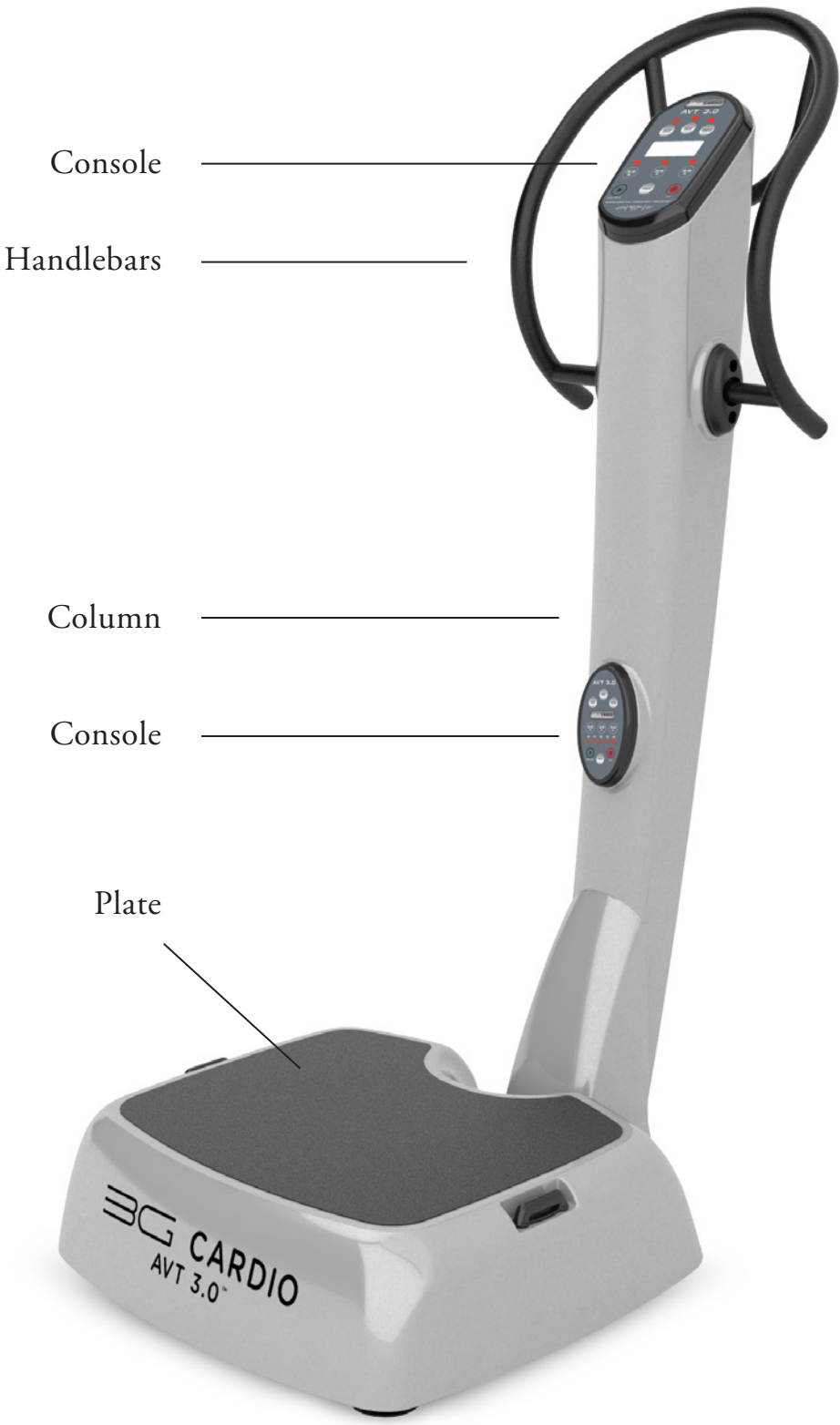

Console

Handlebars

Column

Console

Plate

Assembly Parts List

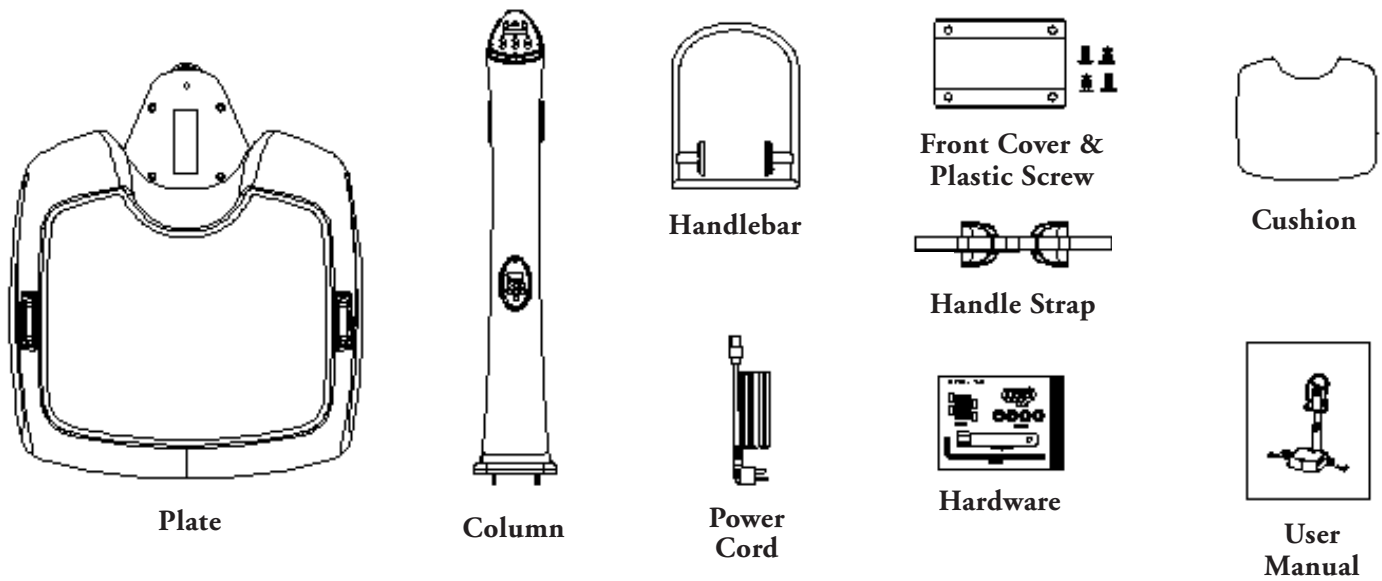

Hardware Pack

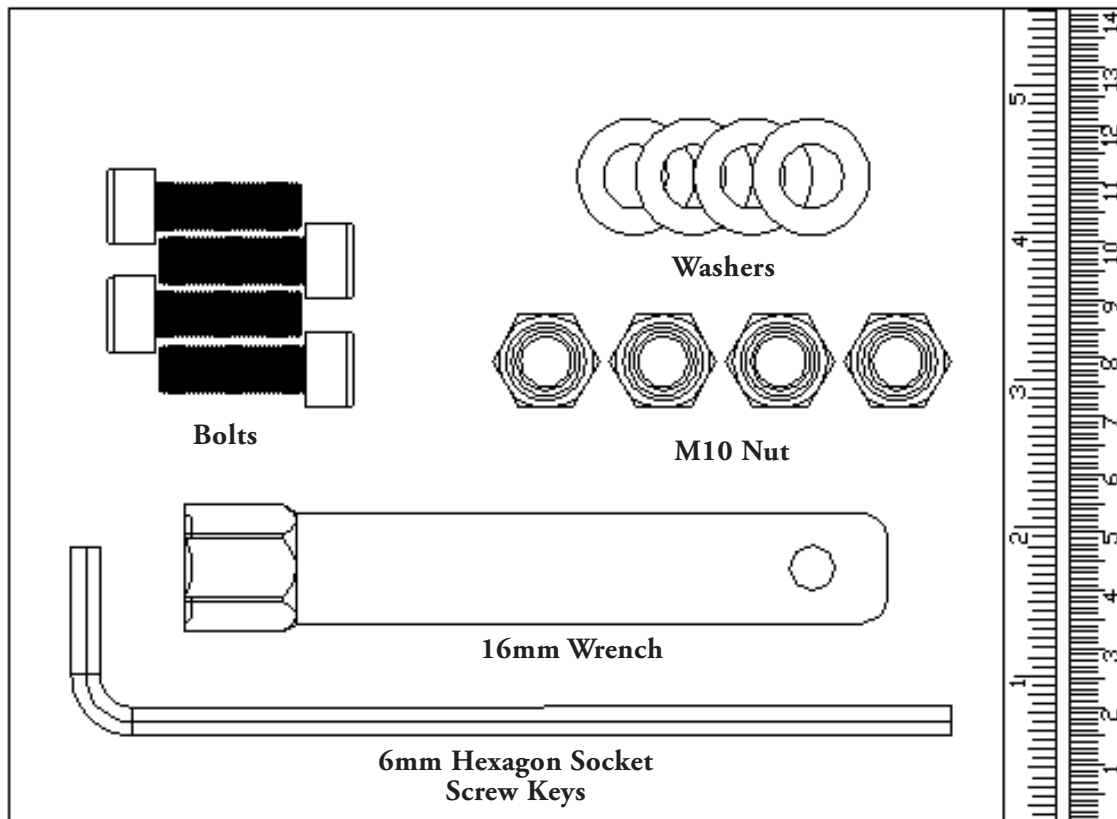

Note: Specifications are subject to change without notice.

Assembly Steps

STEP 1: Preparing for Assembly

Open the carton of the column and check the spare parts, take out the column and spare part. Please move the Expandable Polystyrene to one side of carton and close carton. As support of plate, so that we can assemble the column. (See Pic #1 and #2)



Pic #1
Column packing – Save all packaging



Pic #2
In the next step, unbox the main base and place on top of column packaging.

Step 2: Unbox Base Frame and Assemble

Warning: The outer shell of this vibration machine is made of Fiberglass and can scratch easily if mishandled. Unbox the main base frame and place on top of the upright column packaging (Pic #1). Once you place the base frame on top of the column packaging, you may now connect the upright column to the base frame (Pic #3). By hand, insert (4) #10 washers and M10 nuts. (Pic #4)



Pic #3

Align top and bottom but be careful not to pinch the data cable while tightening bolts down.



Pic #4

Assembly Steps — Continued



Pic #5
Tighten the column to the base



Pic #6
Included Combination Wrench

Step 2 Continued

Lean the machine so that the underneath can be accessed. Again, be careful not to scratch the fiberglass or lose control of the machine while leaning it to the side. While one person holds the machine to the side, the second person can now tighten all four bolts securely.



Pic #7
Connect data plugs – make sure that data cable is not pinched in the frame.



Step 3: Data Cable Wire Connection

Once the bolts are tightened and with the machine still leaning (Pic #7), the second person can now connect the two plugs under the column.

Caution: Make sure that the cord is not pinched during this step as this will harm the cable (Pic #8).

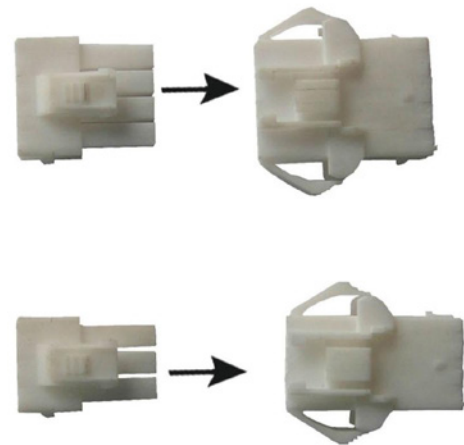

Pic #8
Data cable connection plug

Assembly Steps – Continued

Step 4: Attach Panel Cover to Bottom of Base Frame

With one person still leaning the machine to the side (Pic #9), the second person may now attach the Panel Cover to the bottom of the base plate and securely tighten using (4) bolts as shown in (Pic #10).



Pic #9
Position the Panel cover. Align the bolts and securely tighten.

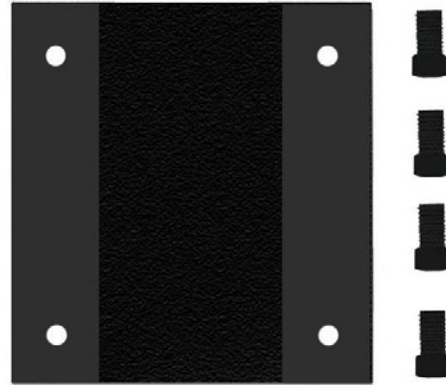

Pic #10

Step 5: Attaching the Hand Straps and Plug-In Power Cord

Secure the hand straps to the base and adjust the length to fit the user. Place the Removable Vibration Dampening Pad on top of the base. (Pic #11) Insert the female end of the power cord into the upright column plug. Now plug the three-prong male outlet power cord into a standard 110v outlet. At this point you are ready to power up the unit.



Pic #11
Slip the hand straps through the side frame holds.



Pic #12
Connect the power cord to the back of the upright column.

NOTICE:

If you have any questions before, during, or after assembly, please do not hesitate to call 3G Cardio Technical Support at 888-888-7985.

Console Operation and Programming AVT 3.0

TIME OPTIONS



30 Seconds



90 Seconds



180 Seconds

FREQUENCY (Hz)



25Hz / 30Hz



35Hz / 40Hz



45Hz / 50Hz

MANUAL MODE

1. When you start the machine, the M (Manual) appears on the display.
2. Press any of the preset time quick keys to set training time(30s/90s/180s)
3. Press any of the HZ quick buttons to set the workout intensity (25/30) (35/40) (45/50).
For example: if you press the Hz button 25/30 once, you will choose 25Hz, if you press the button twice quickly, you will choose 30 Hz.
4. Press START key to begin your chosen workout.

Main Upper Console



Lower Middle Console



Console Operation and Programming AVT 3.0

PROGRAM MODE

For each of the four programs listed below you will see columns labeled as 1-1, 1-2, 1-3 etc... Take for example Program 1 (Abdominal Body Exercise); 1-1 refers to “Program 1; Segment 1”. Reading down the column, you will see that “Segment 1” will last for 60 seconds and run at a 25/30 Hertz frequency. After 60 seconds, “Segment 2” will begin and run for 45 seconds.

This will repeat all the way through 12 different segments before the program ends. The same operation will occur for Program 2 (Lower Body Exercise); Program 3 (Whole Body Exercise) and Program 4 (Upper Body Exercise).

Each of these programs are designed to allow you to focus on a specific body part. The actual exercises you choose to perform for each specific program can be found in the “Exercise Instructions” displayed on the next several pages of this owner’s manual. Please remember to always consult with your doctor before beginning an exercise program. If you should have any questions, please feel free to contact us at 1-888-888-7985.

Program 1 – Abdominal Body Exercise												
Program Segment	1-1	1-2	1-3	1-4	1-5	1-6	1-7	1-8	1-9	1-10	1-11	1-12
Time	60	45	45	30	30	45	45	30	45	45	30	30
Frequency (Hz)	25/30	25/30	25/30	25/30	35/40	35/40	35/40	35/40	35/40	25/30	25/30	25/30

Program 2 – Lower Body Exercise									
Program Segment	2-1	2-2	2-3	2-4	2-5	2-6	2-7	2-8	2-9
Time	60	30	60	60	30	30	60	30	30
Frequency (Hz)	25/30	25/30	35/40	35/40	25/30	35/40	35/40	25/30	25/30

Program 3 – Whole Body Exercise									
Program Segment	3-1	3-2	3-3	3-4	3-5	3-6	3-7	3-8	3-9
Time	60	60	60	45	30	30	30	60	30
Frequency (Hz)	25/30	25/30	25/30	25/30	35/40	35/40	35/40	35/40	25/30

Program 4 – Upper Body Exercise						
Program Segment	4-1	4-2	4-3	4-4	4-5	4-6
Time	60	30	20	30	20	60
Frequency (Hz)	25/30	25/30	35/40	25/30	35/40	25/30

Exercise Instructions



A 01 SQUAT

Stand on the 3G Cardio® AVT™ Vibration Machine with feet shoulder width apart. Keeping the back straight and knees slightly bent gently squeeze the leg muscles. You should feel tension in your quadriceps, buttocks and back.

Tip: Keep good posture with back straight. If you lean slightly forward quadriceps will be emphasized more, if you lean back hamstrings will be used more. Keep body weight on heels.

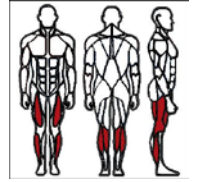

A 02 Deep Squat

Stand on the 3G Cardio® AVT™ Vibration Machine with feet flat and shoulder width apart. Keeping the knees directly above the feet at a 100 degree angle, gently bend the legs and squeeze the leg muscles.

Tip: As with regular squat, keep body weight on heels and try adjusting heel pressure for best results. In addition to controlling how much quads and hamstring are used, varying width of stance will change muscle usage.

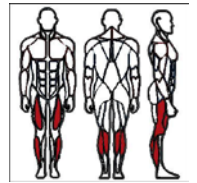

A 03 Wide Stance Squat

Stand on the 3G Cardio® AVT™ Vibration Machine with legs wide apart and toes turned outward. Keeping the knees directly above the feet at a 100 degree angle, gently bend the legs. You should feel tension in the back, buttocks, quadriceps and inner thigh area.

Tip: Experiment with width and heel pressure to find comfortable stance, make sure to keep eyes straight ahead to ensure correct posture with back straight.

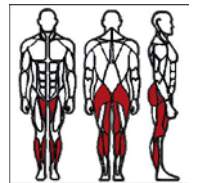

A 04 Lunge

Place one foot in the middle of the 3G Cardio® AVT™ Vibration Machine and step back with the other foot while planting it firmly on the ground behind you. Keeping the back straight and the knees directly above the toes, squeeze the leg muscles. You should feel tension in the hamstrings, quadriceps and buttocks.

Tip: Put your hands on your hips to help with balance if needed. Adjust heel tension as needed.

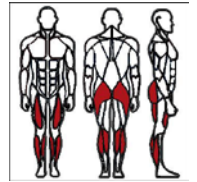

A 05 Calves

Standing in the center of the 3G Cardio® AVT™ Vibration Machine, rise up on to the balls of the feet. Keeping your back straight and abdomen tight, you should begin to feel tension in your calf muscles. To add variation to the exercise, try bending your knees to 90 degrees.

Tip: Squeeze your calf muscles to make it more difficult.

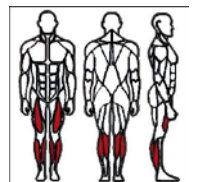

Exercise Instructions



A 06 Triceps Dip

Facing away from the 3G Cardio® AVT™ Vibration Machine, firmly grip the edge and push upwards. Now bend the arms slightly and lower the hips toward the vibration platform plate, squeezing the shoulder blades together. You should feel the tension mainly in your upper arms. For variation, repeat the exercise with your legs straight.

Tip: Vary hand position in and out to train the triceps in different ways.

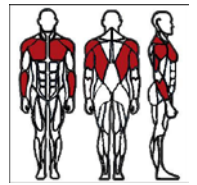

A 07 Biceps Curl

Position your toes slightly under the edge of the 3G Cardio® AVT™ Vibration Machine platform for support and hold the straps tightly at waist height. Knees should be slightly bent, back and wrists kept straight. Pull your arms upward. You should feel tension in the shoulders and biceps.

Tip: Adjust the length of the straps to train the biceps in different ways. Focus on using just biceps to isolate them more.

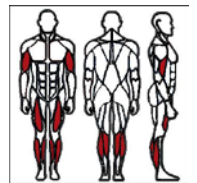

A 08 Bent Over Pull

Stand in front of the 3G Cardio® AVT™ Vibration Machine. Pull the belts upward on the side of your body. Push your chest out and shoulder-blades together. Pull your arms backwards in a smooth motion and you should feel tension in your upper back and shoulder area.

Vary hand position in and out to train the triceps in different ways.

Tip: Adjust the length of the straps and the angle in which you are pulling in order to train the back in different ways.

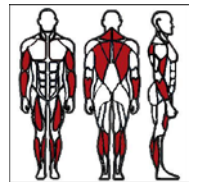

A 09 Front Raise

Stand in front of the 3G Cardio® AVT™ Vibration Machine, legs shoulder width apart and raise both arms horizontally in front of your torso. Keeping your back straight and abdomen strong; pull the straps upward. For variation, perform the same exercise from a standing position on the vibration platform.

Tip: This is a great way to strengthen the rotator cuffs, but don't go past parallel. Keep back straight and eyes straight ahead.

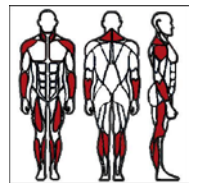

A 10 Shoulder Press

Position the body in a horizontal line parallel with the 3G Cardio® AVT™ Vibration Machine. Hands should be shoulder width apart, legs and back straight, head raised. Using slow and controlled movements push your slightly bent arms toward the vibration platform and then return to the starting position. This exercise is perfect for shoulders and upper arms.

Tip: Change amount of pressure and bend in your arms to find comfortable angle and to vary the workout results.

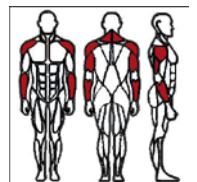

Exercise Instructions



A 11 Lower Abdominals

Brace yourself on your elbows and hold onto the front edge of the 3G Cardio® AVT™ Vibration Machine platform. Now, with a straight back, pull your buttocks up slowly as if you wanted to pull the vibration platform toward your feet. You should feel tension in your abdominal region. To vary the routine, perform the same exercise from a kneeling position.

Tip: This is similar to the Plank exercise, but with even greater results for your core because of the vibrations. Flex and squeeze abs while doing it for even better workout.

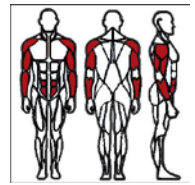

A 12 Standing Abdominals

Stand in the center of the 3G Cardio® AVT™ Vibration Machine, feet shoulder width apart, holding the railing at chest height. Keeping the back straight and legs slightly bent, push your upper torso down. Immediately you'll begin to feel tension in your abdominal muscles.

Tip: To vary the exercise, simply bend your arms further.

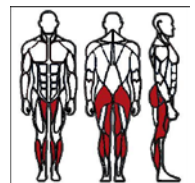

A 13 Lateral Abdominals

With one foot directly behind the other, place one elbow on the 3G Cardio® AVT™ Vibration Machine platform and lean sideways. Keeping your head, torso and legs straight, push your shoulders down and tighten your torso simultaneously. This exercise works the lateral abdomen.

Tip: To add some variety, try pushing your hips upward at the same time.

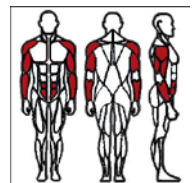

A 14 Push Up

Kneel in front of the 3G Cardio® AVT™ Vibration Machine, placing hands on the vibration platform shoulder width apart with fingers facing inward. With a straight back and strong abdomen, push off the vibration plate platform. This exercise will strengthen chest, shoulder muscles and triceps.

Tip: For variation, try straightening your legs and lifting your knees. Vary width of hand placement by going wide (more back and chest used) or narrow (more triceps used).

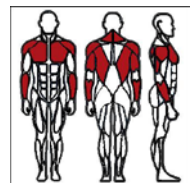

A 15 Abdominal Crunch

Place a pillow under the small of your back, raise your legs and place your hands under your head for support making sure to keep your elbows parallel with the floor. Crunch your upper body toward your legs and feel the tension in the abdominals. Ensure your buttocks and lower back do not lose contact with the platform.

Tip: To vary the routine, lock your feet under the bottom of the upper handles.

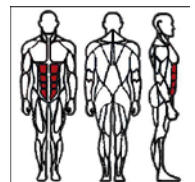

Exercise Instructions



A 16 Lattissimus Dip

Place your hands on the mat, shoulder width apart. Keeping wrists and forearms straight gently push off the handles. It is important to keep the hips straight and to push the shoulders downward. This exercise promotes muscular arms, shoulders and abdomen. Try doing the same exercise but this time keep your legs straight.

Tip: Vary width of hand placement to slightly change workout.

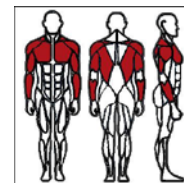

B 01 Hamstring Stretch

Position your body in a wide stance on the 3G Cardio® AVT™ Vibration Machine, buttocks pushed backwards. Holding the handles, let your upper torso drop as far forward as possible. This exercise will stretch the buttock and hamstring muscle groups. Alternatively, stand up straight and let your upper torso and arms drop forward.

Tip: If you are flexible bend over far enough to reach around the back of the column, which will help you stretch farther. Adjust feet width to vary stretch.

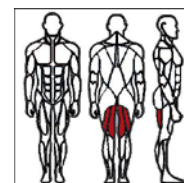

B 02 Quadriceps (Hip Flexor) Stretch

Position your knee and shin on the 3G Cardio® AVT™ Vibration Machine platform ensuring the foot remains off the Plate! Keeping the upper body and back straight, tense your stomach. By pushing your pelvis forward you'll be stretching your quadriceps.

Tip: Vary this exercise by pulling the rear leg forward.

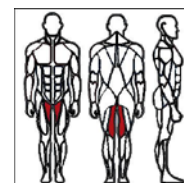

B 03 Calf Stretch

Stand sideways on the 3G Cardio® AVT™ Vibration Machine, with one leg in front of the other and toes facing forward. The front leg should be slightly bent, the rear leg is straight. Push the heel of the rear leg down and you should feel tension in your calves.

Tip: To vary this exercise, keep your back straight and push your pelvis forward. Adjust heel tension to vary as well. Try this stretch also while facing towards the upright column and lean against the handles.

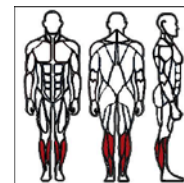

B 04 Adductor Stretch

Stand sideways on the 3G Cardio® AVT™ Vibration Machine with your feet near the support column. Place the outside foot on the floor close to the plate so legs are apart. Bend the outside leg while keeping the other leg straight. While keeping the upper body straight, lower your buttocks to the floor. This exercise will stretch the insides of your thighs. Repeat on the opposite side.

Tip: If you are unfamiliar with this exercise, practice off the vibration plate first to get the hang of it.

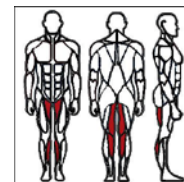

Exercise Instructions



B 05 Shoulder Stretch

Stand with your back to the 3G Cardio® AVT™ Vibration Machine and use your left hand to pull the strap slowly up to your buttocks. Your right hand should be placed on your head while pulling it slightly to the right. Reverse to stretch other shoulder.

Tip: Perform exercise slowly and hold stretch for 5-10 seconds.

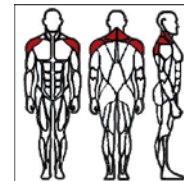

B 06 Pectoral Stretch

Sit with your back to the 3G Cardio® AVT™ Vibration Machine. Push down on the vibration plate platform behind your back so that your fingers grip the edges. By pushing your shoulders down you'll stretch your chest and shoulders.

Tip: You may also gently pull the straps on either side for optimum results.

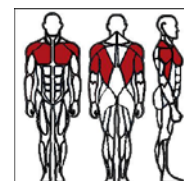

C 01 Calf Massage

Lay in front of the 3G Cardio® AVT™ Vibration Machine with both calves resting on the Vibration plate, toes pointing toward the ceiling. The rest is easy, simply relax and enjoy an invigorating calf massage.

Tip: When using the Vibration plate for massage, focus on controlled, relaxed breathing and relaxing muscles as much as possible.

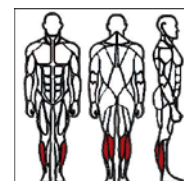

C 02 Upper Arm Massage

Lie sideways facing the 3G Cardio® AVT™ Vibration Machine base, with legs slightly bent. Ensure the Dampening Mat extends slightly over the edge. Rest one arm on the vibration platform and relax.

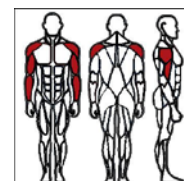

C 03 Adductor Massage

Lie on your side facing the 3G Cardio® AVT™ Vibration Machine. Slightly bend one leg and rest it on the Vibration plate. Making sure your body does not touch the Plate. Now repeat the massage with the other leg.

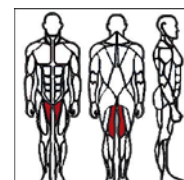

Exercise Instructions

C 04 Abductor Massage

Lie sideways on the 3G Cardio® AVT™ Vibration Machine, with your legs pulled up to your hips. Use your elbow to support your upper body. Your back must be straight. You should feel the massage on the outside of your leg and hip. Repeat the same massage on your other side.

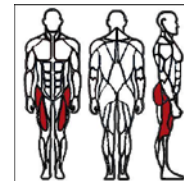

D 01 Shoulder & Neck Relaxer

Kneel down in front of the 3G Cardio® AVT™ Vibration Machine with your arms outstretched. Keep your back and neck straight. Now pull your upper body back while resting your arms on the vibration platform. This exercise will relax your neck and shoulder area.

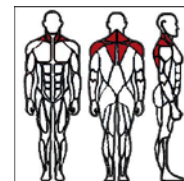

D 02 Lower Back Relaxer

Sit on the floor facing away from the 3G Cardio® AVT™ Vibration Machine with your legs apart. Place the Dampening Mat between your body and the vibration platform and hold the edge's for support. Relax during the vibration, targeted primarily in the lower back.

Tip: As an alternative, angle your legs and push your body harder against the vibration platform.

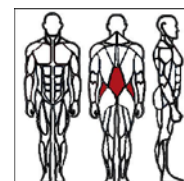

D 03 Upper Body Relaxer

Sit facing away from the 3G Cardio® AVT™ Vibration Machine, with your legs bent. Using your elbows for balance, raise your upper body off the vibration plate. Keeping your neck and back straight, pull your shoulders back. The vibration will relax your upper body.

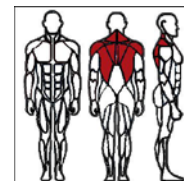

D 04 Back Relaxer

Sit in the center of the 3G Cardio® AVT™ Vibration Machine placing the Dampening Mat under your buttocks with legs apart. Allow your upper body to relax forward. You should feel a pleasant vibration relaxing the back, hip and thigh areas.

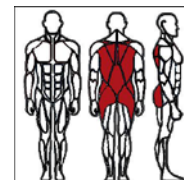

3G Cardio Residential and Commercial Warranties

RESIDENTIAL WARRANTY – A 3G Cardio product placed into an environment where only the members of the immediate family who made the original purchase will use the machine.

MODEL	LABOR	PARTS	MAX USER WEIGHT	DAILY USAGE	VOLTAGE REQUIRED
AVT 3.0	1 Year	2 Years	350lbs	Up to 3 hours	15 amp 110v Outlet

Commercial Warranty: A 3G Cardio product is placed into a location with a business address and therefore not a residential setting.

AVT 3.0 - (Not warranted in commercial environment)

Warranty Information:

This 3G Cardio product is warranted to be free of all defects in material and workmanship.

Original Owner Warranty:

The original 3G Cardio Warranty is only valid and available for the original owner of this machine and is not transferable under any circumstance.

What happens if parts are needed?

If a “part” for a 3G Cardio product is needed and the product is still eligible and covered during the warranty period, 3G Cardio will pay all shipping charges and cover the cost of the needed part. All parts request must be approved by 3G Cardio first. Free shipping and Parts warranty only applies within the United States. For more information, contact your local retailer or contact 3G Cardio at 888-888-7985 or Support@3GCardio.com.

What will void my warranty?

Any failures or damage caused by unauthorized service, misuse, accident, negligence, improper assembly or installation, rust or corrosion as a result of the Product’s location, alterations or modifications without our written authorization or by failure on your part to use, operate and maintain the Product as set out in your User Manual (“Manual”). All terms of this warranty are void if this Product is moved beyond the continental borders of the United States of America (excluding Alaska, Hawaii and Canada) and are then subject to the terms provided by that country’s local authorized representative.

3G Cardio Residential and Commercial Warranties

Owner's Manual:

It is extremely important that you read your Owner's Manual in its entirety and that you fully understand the information provided in this manual before using a 3G Cardio machine. If you have any questions, comments or concerns please contact us immediately at Support@3GCardio.com.

3G Cardio Registration:

Please take a moment and register your new product online at 3GCardio.com. This is the most effective way to ensure that your warranty and product information will be safe in the event you lose your original proof of purchase.

You can also fill out the form below and mail your registration to:

3G Cardio
Attn: Registration Dept.
14647 So. 50th Street Suite 110
Phoenix, AZ 85044



3G Cardio Warranty Registration

First & Last Name _____

Address _____

City _____ State _____ Zip Code _____

Telephone _____ Email _____

Purchased From _____

Serial Number _____

Model Number _____ Date of Purchase _____

3G Cardio • Attn: Registration Dept. • 14647 So. 50th Street, Suite 110 • Phoenix, AZ 85044

Parts List - AVT 3.0

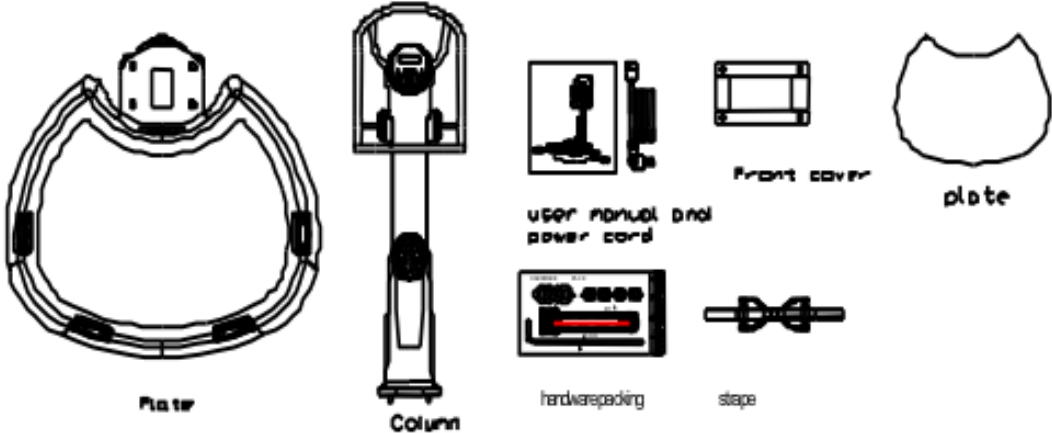

Exploded Drawing - AVT 3.0

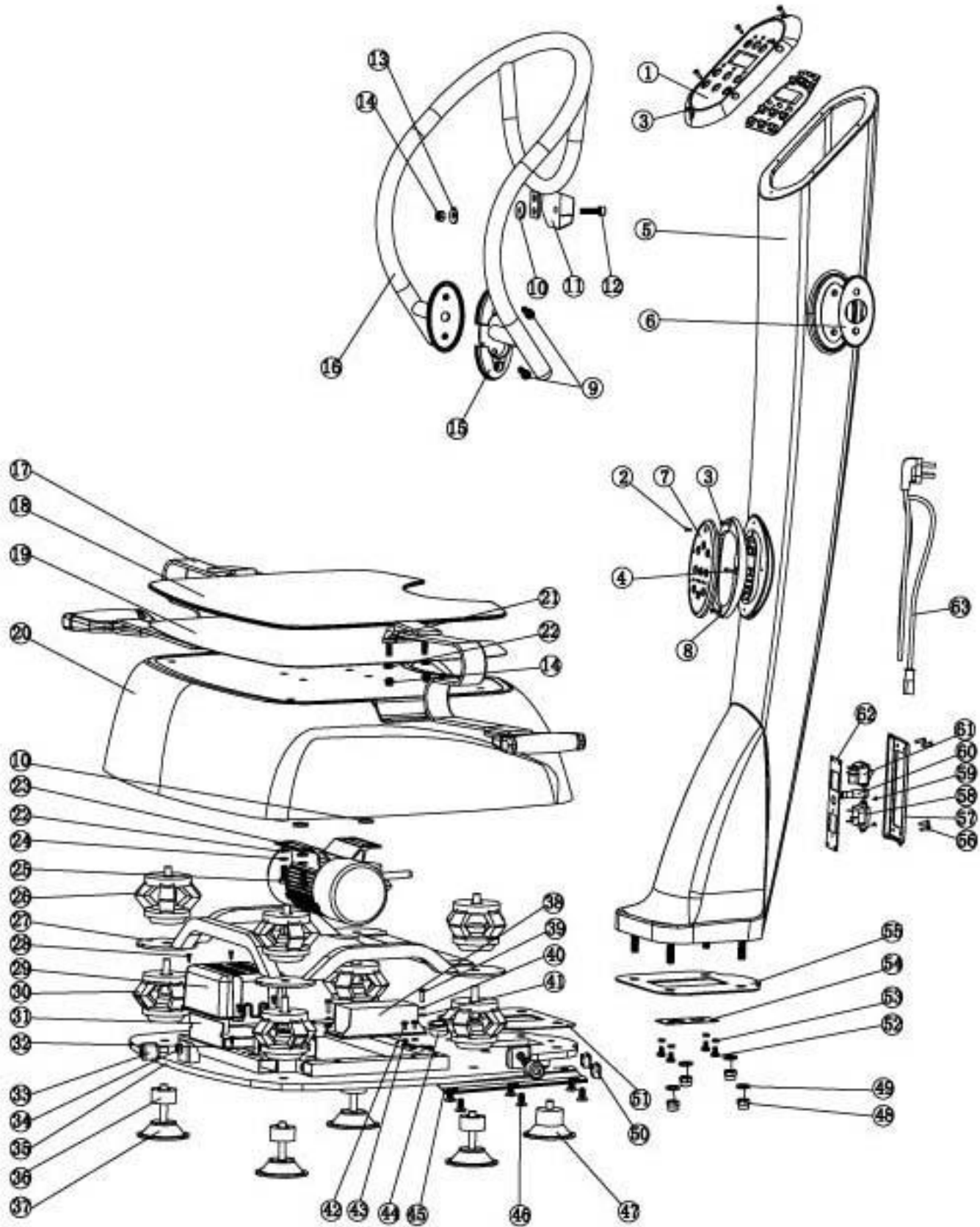

Circuit Diagram

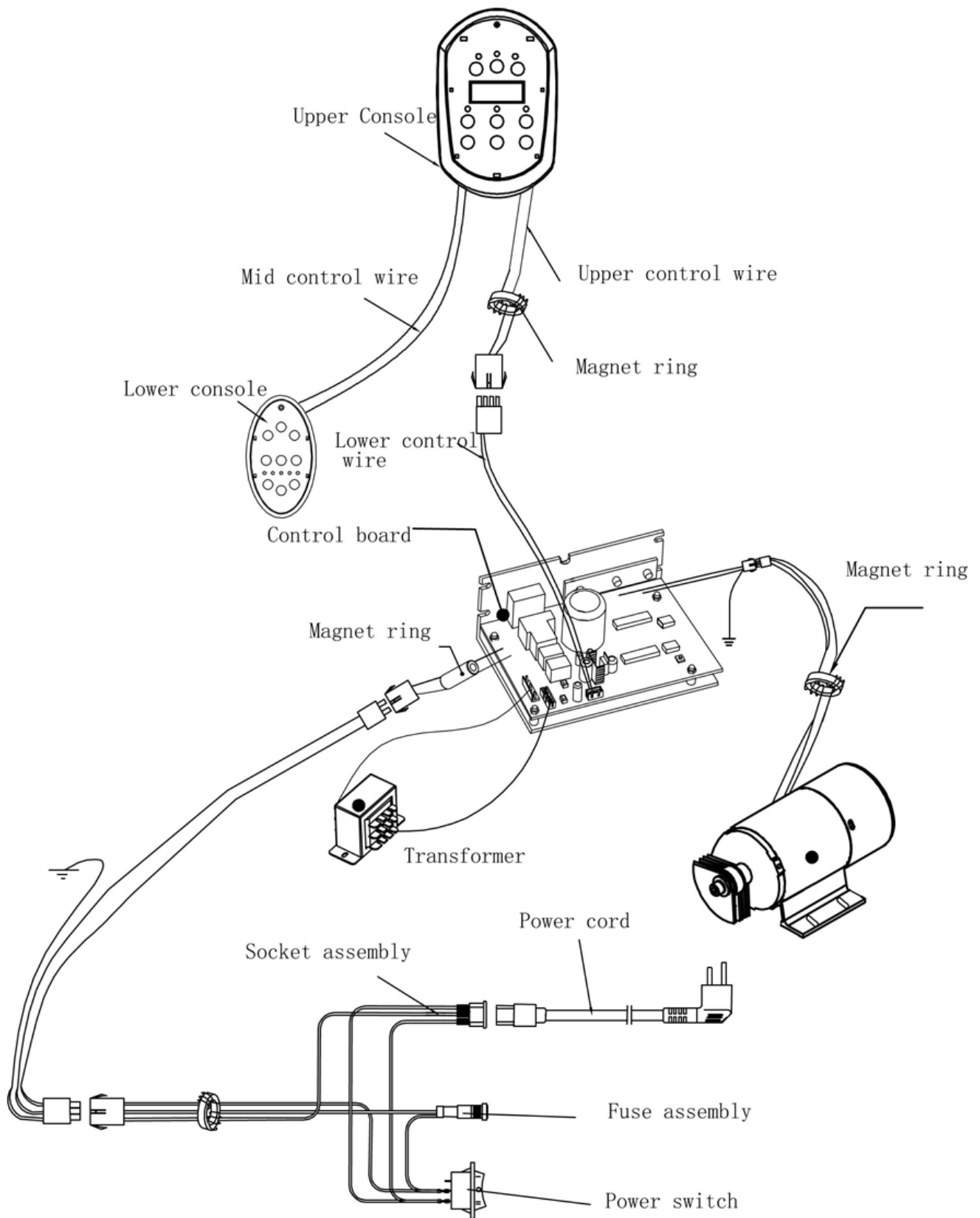



3G Cardio Fitness Equipment
14647 So. 50th Street Suite 110
Phoenix, AZ 85044

1-888-888-7985
www.3GCardio.com